

***Strata***<sup>®</sup> ***CTX***

Digital Business Telephone Systems

**DKT2004-CT**  
**Cordless Digital Telephone**  
**User Guide**

---

## Publication Information

Toshiba America Information Systems, Inc., Telecommunication Systems Division, reserves the right, without prior notice, to revise this information publication for any reason, including, but not limited to, utilization of new advances in the state of technical arts or to simply change the design of this document.

Further, Toshiba America Information Systems, Inc., Telecommunication Systems Division, also reserves the right, without prior notice, to make such changes in equipment design or components as engineering or manufacturing methods may warrant.

CTX-UG-D2004-VA  
4016197

Version A.2, October 2002

---

## © Copyright 2002

### **Toshiba America Information Systems, Inc. Telecommunication Systems Division**

All rights reserved. No part of this manual, covered by the copyrights hereon, may be reproduced in any form or by any means—graphic, electronic, or mechanical, including recording, taping, photocopying, or information retrieval systems—without express written permission of the publisher of this material.

Strata is a registered trademark of Toshiba Corporation.  
Stratagy is a registered trademark of Toshiba America Information Systems, Inc.

Trademarks, registered trademarks, and service marks are the property of their respective owners.

# TOSHIBA AMERICA INFORMATION SYSTEMS, INC. ("TAIS")

## Telecommunication Systems Division License Agreement

IMPORTANT: THIS LICENSE AGREEMENT ("AGREEMENT") IS A LEGAL AGREEMENT BETWEEN YOU ("YOU") AND TAIS. CAREFULLY READ THIS LICENSE AGREEMENT. USE OF ANY SOFTWARE OR ANY RELATED INFORMATION (COLLECTIVELY, "SOFTWARE") INSTALLED ON OR SHIPPED WITH A TAIS TELECOMMUNICATION SYSTEM PRODUCT OR OTHERWISE MADE AVAILABLE TO YOU BY TAIS IN WHATEVER FORM OR MEDIA, WILL CONSTITUTE YOUR ACCEPTANCE OF THESE TERMS, UNLESS SEPARATE TERMS ARE PROVIDED BY THE SOFTWARE SUPPLIER. IF YOU DO NOT AGREE WITH THE TERMS OF THIS LICENSE AGREEMENT, DO NOT INSTALL, COPY OR USE THE SOFTWARE AND PROMPTLY RETURN IT TO THE LOCATION FROM WHICH YOU OBTAINED IT IN ACCORDANCE WITH APPLICABLE RETURN POLICIES. EXCEPT AS OTHERWISE AUTHORIZED IN WRITING BY TAIS, THIS SOFTWARE IS LICENSED FOR DISTRIBUTION ONLY TO END-USERS PURSUANT TO THIS LICENSE AGREEMENT.

- License Grant.** The Software is not sold; it is licensed upon payment of applicable charges. TAIS grants to you a personal, non-transferable and non-exclusive right to use the copy of the Software provided under this License Agreement. You agree you will not copy the Software except as necessary to use it on one TAIS system at a time at one location. Modifying, translating, renting, copying, distributing, transferring or assigning all or part of the Software, or any rights granted hereunder, to any other persons and removing any proprietary notices, labels or marks from the Software is strictly prohibited; You agree violation of such restrictions will cause irreparable harm to TAIS and provide grounds for injunctive relief, without notice, against You or any other person in possession of the Software. You and any other person whose possession of the software violates this License Agreement shall promptly surrender possession of the Software to TAIS, upon demand. Furthermore, you hereby agree not to create derivative works based on the Software. TAIS reserves the right to terminate this license and to immediately repossess the software in the event that You or any other person violates this License Agreement.
- Intellectual Property.** You acknowledge that no title to the intellectual property in the Software is transferred to you. You further acknowledge that title and full ownership rights to the Software will remain the exclusive property of TAIS and/or its suppliers, and you will not acquire any rights to the Software, except the license expressly set forth above. You will not remove or change any proprietary notices contained in or on the Software. The Software is protected under US patent, copyright, trade secret, and/or other proprietary laws, as well as international treaties. Any transfer, use, or copying of the software in violation of the License Agreement constitutes copyright infringement. You are hereby on notice that any transfer, use, or copying of the Software in violation of this License Agreement constitutes a willful infringement of copyright.
- No Reverse Engineering.** You agree that you will not attempt, and if you employ employees or engage contractors, you will use your best efforts to prevent your employees and contractors from attempting to reverse compile, reverse engineer, modify, translate or disassemble the Software in whole or in part. Any failure to comply with the above or any other terms and conditions contained herein will result in the automatic termination of this license and the reversion of the rights granted hereunder back to TAIS.
- Limited Warranty.** THE SOFTWARE IS PROVIDED "AS IS" WITHOUT WARRANTY OF ANY KIND. TO THE MAXIMUM EXTENT PERMITTED BY APPLICABLE LAW, TAIS AND ITS SUPPLIERS DISCLAIM ALL WARRANTIES WITH REGARD TO THE SOFTWARE, EITHER EXPRESS OR IMPLIED, INCLUDING, BUT NOT LIMITED TO, THE WARRANTY OF NON-INFRINGEMENT OF THIRD PARTY RIGHTS, THE WARRANTY OF YEAR 2000 COMPLIANCE, AND THE IMPLIED WARRANTIES OF MERCHANTABILITY AND FITNESS FOR A PARTICULAR PURPOSE. THE ENTIRE RISK AS TO THE QUALITY AND PERFORMANCE OF THE SOFTWARE IS WITH YOU. NEITHER TAIS NOR ITS SUPPLIERS WARRANT THAT THE FUNCTIONS CONTAINED IN THE SOFTWARE WILL MEET YOUR REQUIREMENTS OR THAT THE OPERATION OF THE SOFTWARE WILL BE UNINTERRUPTED OR ERROR-FREE. HOWEVER, TAIS WARRANTS THAT ANY MEDIA ON WHICH THE SOFTWARE IS FURNISHED IS FREE FROM DEFECTS IN MATERIAL AND WORKMANSHIP UNDER NORMAL USE FOR A PERIOD OF NINETY (90) DAYS FROM THE DATE OF DELIVERY TO YOU.
- Limitation of Liability.** TAIS' ENTIRE LIABILITY AND YOUR SOLE AND EXCLUSIVE REMEDY UNDER THIS LICENSE AGREEMENT SHALL BE AT TAIS' OPTION REPLACEMENT OF THE MEDIA OR REFUND OF THE PRICE PAID. TO THE MAXIMUM EXTENT PERMITTED BY APPLICABLE LAW, IN NO EVENT SHALL TAIS OR ITS SUPPLIERS BE LIABLE TO YOU FOR ANY CONSEQUENTIAL, SPECIAL, INCIDENTAL OR INDIRECT DAMAGES FOR PERSONAL INJURY, LOSS OF BUSINESS PROFITS, BUSINESS INTERRUPTION, LOSS OF BUSINESS INFORMATION/DATA, OR ANY OTHER PECUNIARY LOSS OF ANY KIND ARISING OUT OF THE USE OR INABILITY TO USE THE SOFTWARE, EVEN IF TAIS OR ITS SUPPLIER HAS BEEN ADVISED OF THE POSSIBILITY OF SUCH DAMAGES. IN NO EVENT SHALL TAIS OR ITS SUPPLIERS BE LIABLE FOR ANY CLAIM BY A THIRD PARTY.
- State/Jurisdiction Laws.** SOME STATES/JURISDICTIONS DO NOT ALLOW THE EXCLUSION OF IMPLIED WARRANTIES OR LIMITATIONS ON HOW LONG AN IMPLIED WARRANTY MAY LAST, OR THE EXCLUSION OR LIMITATION OF INCIDENTAL OR CONSEQUENTIAL DAMAGES, SO SUCH LIMITATIONS OR EXCLUSIONS MAY NOT APPLY TO YOU. THIS LIMITED WARRANTY GIVES YOU SPECIFIC RIGHTS AND YOU MAY ALSO HAVE OTHER RIGHTS WHICH VARY FROM STATE/JURISDICTION TO STATE/JURISDICTION.
- Export Laws.** This License Agreement involves products and/or technical data that may be controlled under the United States Export Administration Regulations and may be subject to the approval of the United States Department of Commerce prior to export. Any export, directly or indirectly, in contravention of the United States Export Administration Regulations, or any other applicable law, regulation or order, is prohibited.
- Governing Law.** This License Agreement will be governed by the laws of the State of California, United States of America, excluding its conflict of law provisions.
- United States Government Restricted Rights.** The Software is provided with Restricted Rights. Use, duplication, or disclosure by the United States Government, its agencies and/or instrumentalities is subject to restrictions as set forth in subparagraph (c)(1)(ii) of The Rights in Technical Data and Computer Software Clause at DFARS 252.227-7013 (October 1988) or subparagraphs (c)(1) and (2) of the Commercial Computer Software - Restricted Rights at 48 CFR 52.227-19, as applicable.
- Severability.** If any provision of this License Agreement shall be held to be invalid, illegal or unenforceable, the validity, legality and enforceability of the remaining provisions hereof shall not in any way be affected or impaired.
- No Waiver.** No waiver of any breach of any provision of this License Agreement shall constitute a waiver of any prior, concurrent or subsequent breach of the same or any other provisions hereof, and no waiver shall be effective unless made in writing and signed by an authorized representative of the waiving party.

YOU ACKNOWLEDGE THAT YOU HAVE READ THIS LICENSE AGREEMENT AND THAT YOU UNDERSTAND ITS PROVISIONS. YOU AGREE TO BE BOUND BY ITS TERMS AND CONDITIONS. YOU FURTHER AGREE THAT THIS LICENSE AGREEMENT CONTAINS THE COMPLETE AND EXCLUSIVE AGREEMENT BETWEEN YOU AND TAIS AND SUPERSEDES ANY PROPOSAL OR PRIOR AGREEMENT, ORAL OR WRITTEN, OR ANY OTHER COMMUNICATION RELATING TO THE SUBJECT MATTER OF THIS LICENSE AGREEMENT.

**Toshiba America Information Systems, Inc.**  
**Telecommunication Systems Division**

9740 Irvine Boulevard  
Irvine, California 92618-1697  
United States of America

TSDD 081601

5932

# **Toshiba America Information Systems, Inc. Telecommunication Systems Division**

## **Limited Warranty**

Toshiba America Information Systems, Inc., (“TAIS”) warrants that this voice processing equipment (except for fuses, lamps, and other consumables) will, upon delivery by TAIS or an authorized TAIS dealer to a retail customer in new condition, be free from defects in material and workmanship for twenty-four (24) months after delivery. This warranty is void (a) if the equipment is used under other than normal use and maintenance conditions, (b) if the equipment is modified or altered, unless the modification or alteration is expressly authorized by TAIS, (c) if the equipment is subject to abuse, neglect, lightning, electrical fault, or accident, (d) if the equipment is repaired by someone other than TAIS or an authorized TAIS dealer, (e) if the equipment’s serial number is defaced or missing, or (f) if the equipment is installed or used in combination or in assembly with products not supplied by TAIS and which are not compatible or are of inferior quality, design, or performance.

The sole obligation of TAIS or Toshiba Corporation under this warranty, or under any other legal obligation with respect to the equipment, is the repair or replacement by TAIS or its authorized dealer of such defective or missing parts as are causing the malfunction with new or refurbished parts (at their option). If TAIS or one of its authorized dealers does not replace or repair such parts, the retail customer’s sole remedy will be a refund of the price charged by TAIS to its dealers for such parts as are proven to be defective, and which are returned to TAIS through one of its authorized dealers within the warranty period and no later than thirty (30) days after such malfunction, whichever first occurs.

Under no circumstances will the retail customer or any user or dealer or other person be entitled to any direct, special, indirect, consequential, or exemplary damages, for breach of contract, tort, or otherwise. Under no circumstances will any such person be entitled to any sum greater than the purchase price paid for the item of equipment that is malfunctioning.

To obtain service under this warranty, the retail customer must bring the malfunction of the machine to the attention of one of TAIS’ authorized dealers within the twenty-four (24) month period and no later than thirty (30) days after such malfunction, whichever first occurs. Failure to bring the malfunction to the attention of an authorized TAIS dealer within the prescribed time results in the customer being not entitled to warranty service.

**THERE ARE NO OTHER WARRANTIES FROM EITHER TOSHIBA AMERICA INFORMATION SYSTEMS, INC., OR TOSHIBA CORPORATION WHICH EXTEND BEYOND THE FACE OF THIS WARRANTY. ALL OTHER WARRANTIES, EXPRESS OR IMPLIED, INCLUDING THE WARRANTIES OF MERCHANTABILITY, FITNESS FOR A PARTICULAR PURPOSE, AND FITNESS FOR USE, ARE EXCLUDED.**

No TAIS dealer and no person other than an officer of TAIS may extend or modify this warranty. No such modification or extension is effective unless it is in writing and signed by the vice president and general manager, Telecommunication Systems Division.

# Contents

---

## Introduction

Organization.....	v
Conventions .....	vi
Related Documents/Media.....	vii

## Chapter 1 – The Grand Tour

Applications .....	2
Benefits .....	2
Cordless Digital Telephone Standard Parts .....	4
Base Unit Controls and Functions .....	5
Features .....	6

## Chapter 2 – Installation

Removing and Charging Your Battery Pack .....	14
Charging Extra Battery Packs.....	14
Tips on Extending Battery Pack Life.....	15
Installing Optional Headset.....	15

## Chapter 3 – Configuration

Entering Program Mode.....	17
----------------------------	----

## Chapter 4 – The Handset

Handset Volume Level .....	19
Ringer Volume Level.....	19
Mute.....	19

## Contents

### Chapter 5 – Features

Using the Handset .....	20
Charging the Handset.....	20
Switching a Call to Your Cordless Digital Telephone.....	21
Switching a Call to the Desk Telephone.....	22
Using Memory .....	23
Chain Dialing.....	24

## Chapter 5 – Features

Account Code Calls .....	25
Verified/Non-Verified Account Codes.....	26
Forced Account Codes.....	26
Voluntary Account Codes (Verified/Non-Verified).....	27
Automatic Busy Redial .....	27
Automatic Callback .....	28
Auto Redial .....	29
Call Forward .....	29
System.....	29
Station .....	29
Call Forward Categories .....	30
Call Forward Settings .....	30
Call Park Orbits.....	33
Call Pickup.....	35
Group Pickup.....	35
Page/Internal Call Pickup .....	35
Call Waiting.....	37
Direct Station Selection Buttons (Hotline) .....	37
Do Not Disturb.....	38
Setting DND for Another Extension.....	38
Door Lock(s).....	39
Door Phone(s) .....	40
Emergency Ringdown.....	41
Held Calls.....	41
Placing Line Appearances or [DN] Calls on Hold .....	41
Retrieving Held Calls .....	42
Using Automatic Hold.....	42

Switching Between Calls .....	42
ISDN Outgoing Calling .....	43
Subaddress .....	43
Message Waiting .....	44
Responding to a Lit Msg LED .....	44
Off-hook Call Announce .....	45
Override Calls .....	45
Busy Override .....	45
Do Not Disturb Override .....	46
Executive Override .....	46
Class of Service Override .....	47
Privacy Override .....	47
Paging .....	47
Answering a Page .....	48
All Call Page .....	48
Emergency Page .....	48
Privacy .....	49
Redial .....	49
Release and Answer .....	50
Speed Dial .....	50
Making a Call Using Speed Dial .....	51
Tone/Pulse Dialing .....	51
Voice Mail - Direct Transfer .....	51
Troubleshooting .....	60
Range and Performance .....	61
Nine Simultaneous Conversation Channels .....	61
Radio Interference .....	62
Specifications .....	62
<b>Index</b> .....	<b>63</b>

## **Contents**

*Chapter 5 – Features*



# Introduction

---

This guide describes the features and operation of the Toshiba DKT2004-CT 900 MHz Cordless Digital Telephone with Strata CTX Business Telephone Systems. To get the most from your cordless digital telephone, please read this guide thoroughly.

The DKT2004-CT also works with Strata DK telephone systems (except Strata DK24/56/96, Release 3). Refer to the appropriate user guide for your telephone system (see [“Related Documents and Media”](#) on page x).

## Organization

This user guide is divided as follows:

- **Chapter 1 – The Grand Tour** covers an equipment overview by describing the features associated with the cordless digital telephone.
- **Chapter 2 – Installation** covers instructions for installing your cordless digital telephone with your Strata CTX System.
- **Chapter 3 – Configuration** covers the configuration options for optimizing the performance of your cordless phone.
- **Chapter 4 – The Handset** covers the various controls and features related to operating your cordless phone.
- **Chapter 5 – Features** covers operation of the cordless digital telephone features.
- **Appendix A – Feature Access Codes** provides the feature access code dialing sequence.
- **Appendix B – Troubleshooting and Specifications** covers descriptions of the Optional Headset, Installation, Troubleshooting, Range, Telephone Line Problems, Specifications and Available Optional or Replacement Items.

# Conventions

Conventions	Description
<b>Note</b>	Elaborates specific items or references other information. Within some tables, general notes apply to the entire table and numbered notes apply to specific items.
<b>Important!</b>	<i>Calls attention to important instructions or information.</i>
<b>WARNING!</b>	Alerts you when the given task could cause personal injury or death.
P	Represents any Directory Number button, also known as an extension or intercom number.
[PDN]	Represents any Primary Directory Number button (the extension number for the telephone).
[SDN]	Represents any Secondary appearance of a PDN. A PDN that appears on another telephone is considered an SDN.
[PhDN]	Represents any Phantom Directory Number button (an additional DN).
<b>Arial Bold</b>	Represents telephone buttons.
<b>Courier</b>	Shows a computer keyboard entry or screen display.
<b>BOLD CAPS</b>	Shows Liquid Crystal Display (LCD) messages.
Tilde (~)	Means “through.” Example: 350 ~ 640 Hz frequency range.
➤	Denotes the step in a one-step procedure.
➤	Denotes a procedure.
<a href="#">See Figure 10</a>	Grey words within the printed text denote cross-references. In the electronic version of this document (Strata CTX WinAdmin Application Software and Documentation Library or FYI Internet download), cross-references appear in blue hypertext.

## Related Documents/Media

**Note** Some documents listed here may appear in different versions on the CD-ROM or in print. To find the most current version, check the version/date in the Publication Information on the back of the document's title page.

Refer to the following for more information:

- Strata CTX WinAdmin Application Software and Documentation Library

For DKT2004-CT telephones connected to a Strata DK14, DK16e, DK16, DK24/56/96 (Release 4.0), DK40i, DK40, DK280 (Release 3.0 or higher), DK424i, DK424, refer to:

- Strata DK DKT2004-CT Cordless Digital Telephone User Guide

## **Introduction**

*Related Documents/Media*

Your cordless digital telephone is designed and engineered to work with your Toshiba digital telephone system and provide you with reliability, long life, and outstanding performance. The cordless digital telephone is compatible with all Strata CTX systems. All it requires for connection is a digital station port.

Your cordless digital telephone uses digital 900 MHz spread-spectrum technology, which represents state-of-the-art design and engineering. This provides unsurpassed range, several times greater than conventional analog or cordless digital telephones. It provides clarity that is so good, it is indistinguishable from corded telephones in most environments. It also provides fully secure communications for up to nine cordless digital telephones within a given environment.

Fully charged, your cordless digital telephone provides over 3 hours of talk time and 42 hours of standby. There is a fast charger in the handset and a trickle charger in the base.

The cordless digital telephone provides many of the same features as a 3000/2000-series corded digital key telephone (DKT):

- 20-character Liquid Crystal Display LCD (displays top 16 characters of DKT)
- Four programmable buttons for feature or multiple-line access (same as first four buttons on DKT station port)
- Headset jack
- Handset volume adjustment (three levels)
- Two ring levels and a vibration mode
- **Cnf/Trn** button
- **Msg** button with Message Waiting LED

- **Hold** button
- Twenty-speed dial memory (stored in the telephone separate from 40 individual and system speed dial numbers)

Your cordless digital telephone offers two different modes of operation. You can use it either in conjunction with a 3000/2000-series digital telephone, or on a stand-alone basis. When used with a DKT, both the cordless digital telephone and the DKT share the same digital station port on the PDKU. It also shares the same extension number.

You can switch between use of your DKT and your cordless, just by pressing a button. When used on a stand-alone basis, the cordless digital telephone attaches to its own digital station port on the PDKU.

Several useful accessories are available:

- Base wall mount
- Headset
- Heavy duty 5.5-hour battery
- Separate deep cycle charger

## Applications

Your cordless digital telephone brings mobility and productivity to office telephones. Greater call access cuts down on “telephone tag” delays. Its compact design makes it easy to take with you.

## Benefits

Your cordless digital telephone uses advanced technology and provides important features that place it far above the competition in functionality and value. You benefit from much greater performance than other cordless telephones currently available. This means better sound quality, longer range, greater security, multi-line access, helpful LCD display information, and many other important advantages.

The cordless digital telephone provides many advantages over a single-line analog or digital telephone. Some of those advantages are:

- Multi-line access is available on up to four programmable buttons. These buttons can be used for CO line appearances, multiple [DN] appearances, or features. If the cordless telephone is attached to a 3000/2000-series desk telephone, the four programmable buttons are the same as the first four buttons on the desk DKT.
- Your cordless digital telephone rings to the same extension number as the regular DKT it is used with, enabling you to answer via either telephone. Both follow the same forwarding and hunting regardless of which telephone is in use. This is much simpler than having a separate extension number and standard station port for a single-line cordless, in which, if you use both phones, you must forward the DKT telephone to the single-line telephone (SLT).

An SLT cordless is not only a cumbersome alternative to the Toshiba digital cordless; but also, if you forget to forward your calls, you cannot receive the calls on your SLT cordless. With your cordless digital telephone it is easy. Just press a button, grab your cordless, and go!

- Message Waiting LED that is activated just like any regular DKT. This is a big advantage over a single-line cordless, which, for example, cannot light message waiting from voice mail.
- Spread-spectrum technology provides five to seven times greater range than conventional cordless telephones, making your cordless digital telephone much more useful and valuable.
- 900 MHz spread-spectrum operation provides maximum security with a frequency range that is almost impossible to scan. Regular 900 MHz cordless digital telephones are difficult to scan, but less so than spread spectrum. Analog cordless telephone frequencies are easy to scan and provide virtually no security from the outside. Hackers and thieves can use this to hear conversations and pick up credit card numbers.
- Sound quality is better on your cordless digital telephone than non-spread spectrum 900 MHz digital cordless phones. Sound quality on conventional analog cordless telephones is so poor by comparison that they are only practical for short range usage.

# Cordless Digital Telephone Standard Parts

Your Toshiba cordless digital telephone includes the following items:

- Handset
- Base
- AC Adapter
- Two-foot phone cord
- 400 mAh Rechargeable Battery
- Belt Clip
- User Guide

If any of these items are missing, damaged or if you would like replacement parts, contact your System Administrator.



# Base Unit Controls and Functions

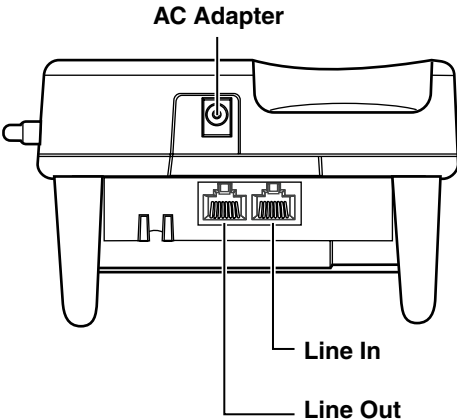
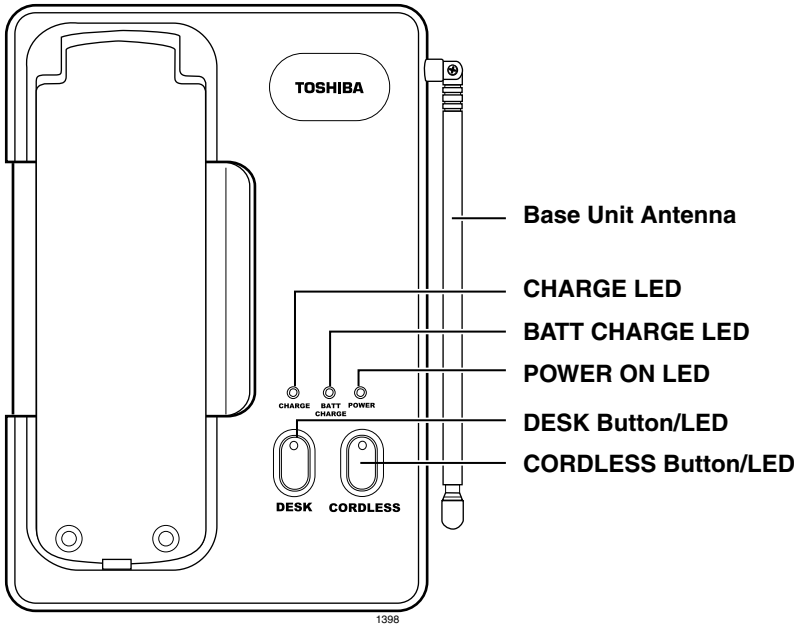

# Features

- Super Long Range 900 MHz Spread Spectrum
- 2-line, 10-digit LCD Display
- Headset Jack
- Ringer Volume Control
- Handset Volume Control
- Message Waiting LED
- Single button access to Conference, Hold, Message Waiting, and Transfer features
- Four Flexible Function Keys (First four keys of DKT port in Strata CTX)
- 20-Number Memory Store and Search
- Battery Charging System for Optional Standby Battery
- 2-Way Handset Mounting
- Vibration Ringer Alert
- Compact Handset Design

**Important!** Your telephone system must be programmed for Auto Preference for your **TALK** button to work. If there is a shared digital telephone, you receive internal system dial tone automatically after picking up the handset of your deskset. It is best to set Auto Line Preference to access Intercom dial tone.

## Step 1: Review Safety Instructions

This equipment contains a rechargeable Sealed Lead-Acid battery. Before you read anything else, please observe the following:

**WARNING!** Toshiba *does not* represent this unit to be waterproof. To reduce the risk of fire, electrical shock, or damage to the unit, *do not* expose this unit to rain or moisture.

*Do not* dispose of the Sealed Lead-Acid battery in fire because it could explode.

*Do not* charge the Sealed Lead-Acid battery in any charger other than the one designed to charge it as specified in this user guide. Using another charger could damage the battery or cause it to explode.

To reduce risk of fire, use only Model EXP-9590 batteries.

## Installation

### Step 1: Review Safety Instructions

---

**CAUTION! To power your Toshiba DKT2004-CT Cordless base unit, use only UL Listed AC Adapter Model AD-960 Class 2 Power Supply.**

**Ratings are:**

**Input: 120VAC 14W**

**Output: 10VDC 500mA**

---

- Read and understand all instructions.
- Follow all warnings and instructions marked on the product.
- Unplug this product from the wall outlet before cleaning. Do not use liquid cleaners or aerosol cleaners. Use a dry cloth for cleaning.
- Do not place this product on an unstable cart, stand, or table. The telephone may fall, causing serious damage to the unit.
- To protect the product from overheating, do not block or cover any slots or openings in the base Unit. This product should never be placed near or over a radiator or heat register. This product should not be placed in an enclosed cabinet unless proper ventilation is provided.
- Operate this product only from the type of power source indicated on the marking label.
- Do not allow anything to rest on the power cord. Do not locate this product where the cord will be damaged by persons walking on it.
- Do not overload wall outlets and extension cords, as this can result in the risk of fire or electrical shock.
- Never push objects of any kind into this product through the Base Unit slots, as they may touch dangerous voltage points or short out parts that could result in a risk of fire or electric shock. Never spill liquid of any kind on the product.
- To reduce the risk of electric shock, do not disassemble this product. Contact qualified service personnel when service or repair work is required. Opening or removing covers may expose you to dangerous voltages or other risks. Incorrect reassembly can cause electric shock when the appliance is subsequently used.
- Unplug this product from the wall outlet and refer servicing to qualified service

personnel under the following conditions:

- When the power supply cord is damaged or frayed.
  - If liquid has been spilled into the product.
  - If the product has been exposed to rain or water.
  - If the product does not operate normally when following the operating instructions. Adjust only those controls that are covered by the operating instructions. Improper adjustment of other controls may result in damage, and will often require extensive work by a qualified technician to restore the product to normal operation.
  - If the product has been dropped, or the cabinet has been damaged.
  - If the product exhibits a distinct change in performance.
- Do not use the telephone to report a gas leak in the vicinity of the leak.

**WARNING! To reduce the risk of fire or injury to persons by the battery, follow these instructions:**

- Use only battery pack model EXP-9590. Use of any other battery may cause a safety hazard.
- Do not open or mutilate the battery pack. Released electrolyte is corrosive and may cause damage to the eyes or skin, and, if swallowed, may be toxic.
- Exercise care in handling the battery in order not to short the battery with conducting materials such as rings, bracelets, and keys. The battery or conductor may overheat and cause burns.
- Observe proper polarity orientation between the battery pack and battery charger.
- Under federal, state and local laws, it may be illegal to dispose of old batteries by placing them in the trash. Check with your local government for information on where to recycle or dispose of old batteries. If you cannot find the information you need, contact Toshiba for assistance.

## Installation

### Step 2: Select Location

#### **Important!**

- *Do not short circuit the battery.*
- *Residents of Minnesota should contact 1-800-225-PRBA for information concerning reclamation and disposal of Rechargeable Nickel-metal Hydride batteries.*
- *Residents outside of Minnesota should contact their local authorities for information concerning reclamation and disposal of Rechargeable Nickel-metal Hydride batteries.*
- *Charge the battery for 10 hours before using your new Cordless Digital Telephone.*

## Step 2: Select Location

1. Select a location for your cordless digital telephone. Avoid excessive heat or humidity.
2. Place the cordless digital telephone's base unit on a desk or tabletop near a standard 120VAC outlet and within reach of the digital telephone line connection to your Strata CTX system.
3. Keep the base unit and handset away from sources of electrical noise (motors, fluorescent lighting, etc.).

**Important!** Place the cordless telephone to the right of the DKT. If placed on the left of the DKT, the cordless antenna picks up a tone due to its close proximity to the DKT speaker and electronic parts.

## Step 3: Connect Telephone Cords

Your cordless digital telephone can be used as a stand-alone telephone or in conjunction with your deskset.

There are two telephone line jacks on the back of the base unit of your cordless digital telephone: “Line In” and “Line Out.” You can connect your cordless digital telephone to both the telephone line and a Strata CTX digital telephone.

► **To use as a stand-alone telephone**

- Connect the modular jack labeled “Line In” to the telephone wall jack.

► **To use with a desk telephone**

1. Unplug the telephone line cord from your desk telephone.
2. Connect this cord to “Line In” of your cordless telephone.
3. Using the two foot modular cord that came with your cordless telephone, connect the jack labeled “Line Out” to the desk telephone.

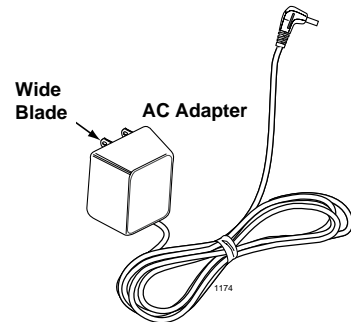

## Step 4: Connect and Apply Power to Base Unit

**Note** The AC adapter furnished with this telephone may be equipped with a polarized line plug (a plug having one blade wider than the other). This plug fits into the power outlet only one way. If you are unable to insert the plug fully into the outlet, try reversing the plug. If the plug still does not fit, contact your facilities coordinator about replacing the obsolete plug. Do not alter the shape of the blades on the polarized plug.

## Installation

### Step 4: Connect and Apply Power to Base Unit

1. Plug the AC adapter cord into the AC adapter input jack on the base unit.

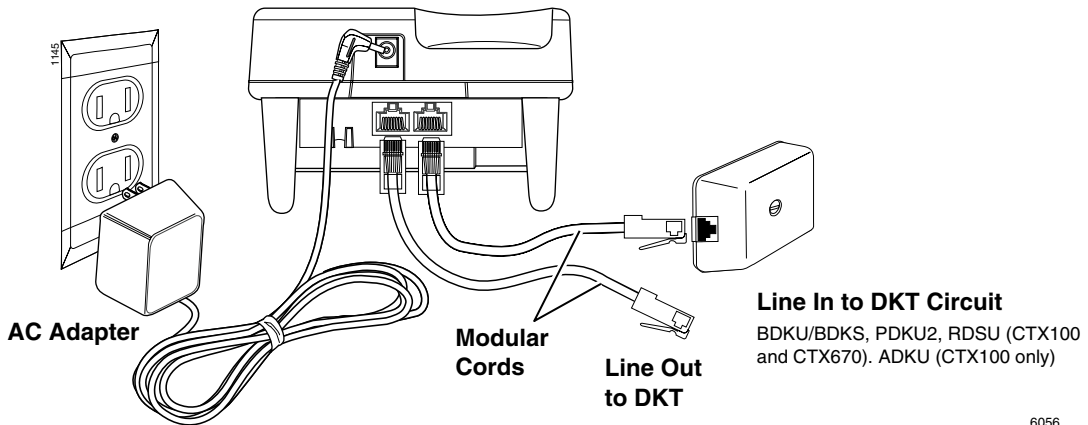

---

**CAUTION! Use only the AC adapter supplied with your cordless digital telephone.**

---

2. Plug the AC adapter into a standard 120 VAC wall outlet.
3. Route the power cord where it is not a trip hazard, and where it cannot become chafed and create a fire or electrical hazard.
4. Wrap the power cord around the notch on the bottom of the base unit as shown at the right.
5. Check to see that the power LED is on, indicating the telephone has power.
6. Before using your cordless digital telephone, be sure to raise the antenna to the vertical position.

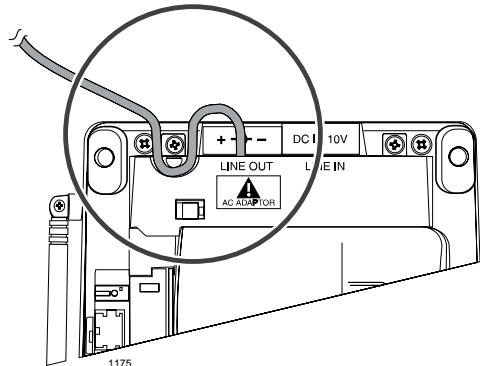



## Step 5: Attach Belt Clip to Handset (optional)

### ► To attach the belt clip to the handset

1. Snap the tabs of the belt clip into the notches on the sides of the handset.
2. Use the belt clip to attach the handset to your belt or pocket for convenient portability.

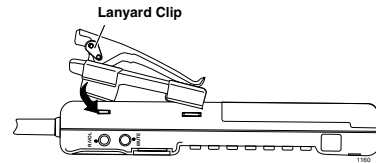

### ► To remove the belt clip

1. Pry one tab at a time from the notch on the side of the handset.
2. Carefully lift the belt clip off.

**Note** The belt clip is designed to fit snugly onto the handset.

## Step 6: Install Handset Battery Pack

1. Place a charged battery pack onto the handset so that it slides easily along the ridges.

If your battery is not charged, see [“Removing and Charging Your Battery Pack” on Page 14.](#)

2. Slide the battery pack up onto the handset until it clicks into place.

You are now ready to configure your cordless digital telephone. See “Configuration” on page 17.

**Important!** *Before using your new cordless phone, the battery must be charged continuously for 10 hours.*

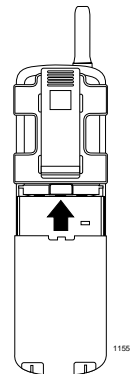

# Removing and Charging Your Battery Pack

**Important!** Before using your new cordless digital telephone, the battery must be charged continuously for six to eight hours.

➤ **To remove the handset's battery pack**

1. Press in on the battery pack release latch.
2. Slide the battery pack off the handset (shown right).

**Note** You may have to pull hard to slide the battery pack off, when the handset is new.

➤ **To charge the handset's battery pack**

1. Place the handset on the base unit.
2. Make sure the CHARGE LED lights. If it does not light, make sure the AC adapter is plugged in and that the handset makes good contact with the base unit.

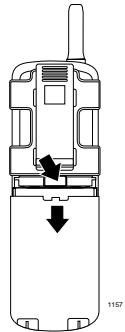

## Charging Extra Battery Packs

The base unit of your cordless telephone has a battery charger for charging an extra battery pack. A compartment latch keeps the battery pack in place during charging.

➤ **To charge extra battery packs**

1. Position the battery pack so the inner side is facing toward the top of the base unit.
2. Slide the battery pack into the charging compartment until it clicks into place.
3. Make sure the BATTERY CHARGE LED lights. If it doesn't light, make sure the AC adapter is plugged in and that the battery pack is seated into the charging compartment.

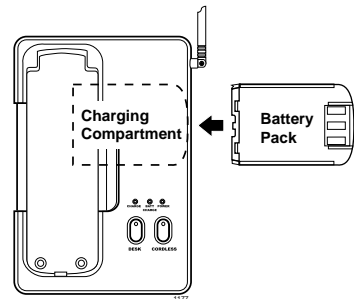

**Note** Charge the standard 400 mAh battery pack without interruption for six to eight hours. Charge the optional 730 mAh extended battery pack without interruption for eight to ten hours.

## Tips on Extending Battery Pack Life

All rechargeable nickel cadmium batteries can develop a “memory” (reduced charge capacity) caused by repeated charge and discharge cycles. Batteries that have developed this effect do not operate to their fullest capacity.

- To avoid memory effect, operate the unit until the battery pack is completely discharged before recharging. For example, use the handset off the base all day. Only replace the handset on the base at night after a full day of use. Do not “top off” the charge after using the battery for a short time.
- To erase memory effect, operate the unit until the battery pack is completely discharged, then recharge it fully. Repeat this process at least three times.

When the battery pack in the handset is low and needs to be charged you see **LOW BATT** and the handset beeps.

**Table 1      Low Battery Symptoms**

On a Call	In Standby Mode
Only the TALK key operates.	None of the keys operate.
Handset beeps once every three seconds.	Handset beeps once.
Complete your call as quickly as possible.	Cannot make call.
Replace battery pack.	Replace battery pack before making a call.

To restore your battery capacity, return the handset to the base unit for charging or replace the handset battery pack with another charged one.

## Installing Optional Headset

The optional headset provides a hands-free option for the cordless digital telephone. Only use headsets especially designed or modified for use with radio frequency equipment. With the headset installed, you can use the belt clip to carry the handset and converse through the headset.

- Open the cover over the headset jack and plug in the headset.
- All feature operations are the same as with the handset. When using the headset, the handset earphone and microphone are disconnected.

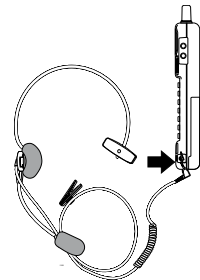

## **Installation**

### *Installing Optional Headset*

This chapter explains how to enter the Programming Mode. Your cordless digital telephone can operate in either the DKT or the cordless mode and can be programmed whenever the telephone is idle. When entering the program mode during cordless operation, all calls coming to this station are ringback tone until the program mode is ended. Entering the program mode during DKT operation has no effect on current call status.

## Entering Program Mode

1. Remove the handset from the base unit.
2. Press and hold \* and # at the same time.

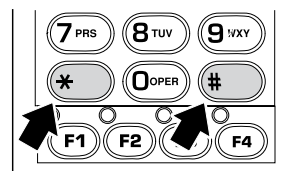

3. While holding \* and #, press **TALK**.
4. Release all three keys.
5. Press the **R/VOL** button on the upper right side of the cordless handset until you toggle to the DATA STORE settings screen.
6. Press **0** to toggle the settings for each program step or store (save) the setting when in DATA STORE step.
7. Press **TALK** at any time to exit PROGRAM without saving changes. To save the changes step to DATA STORE and press **0** before pressing **TALK**.

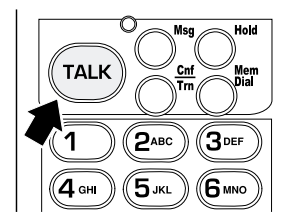

## Configuration

### Entering Program Mode

- Press **MUTE** to step through the program steps in the reverse order.

The LEDs above the **F1~F3** buttons indicate the current setting for each of the program steps. Each time the feature is entered and digit **0** is pressed these LEDs change their indication.

You see the following screens on the cordless LCD prompting you to configure your handset:

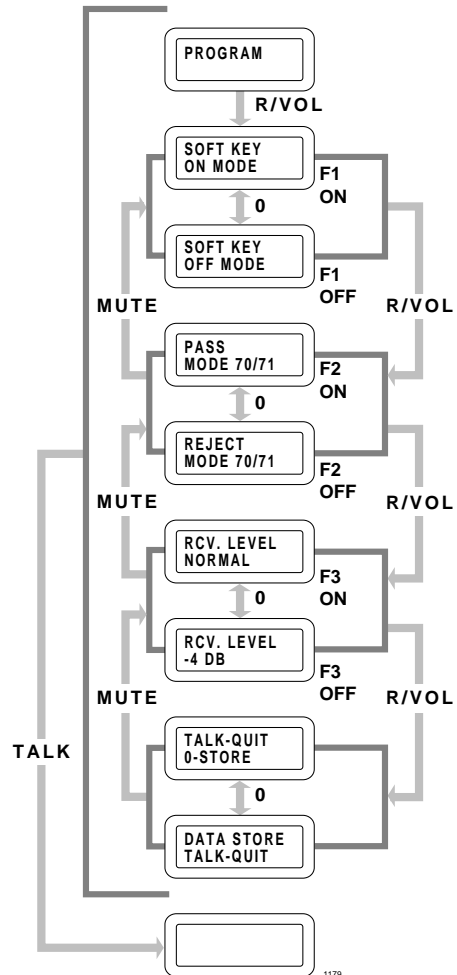

1179

This chapter covers the handset volume control and various functions related to the handset itself.

## Handset Volume Level

- Press the **R/VOL** button on the side of the handset (shown right) while on a call to select a loud or soft volume level.

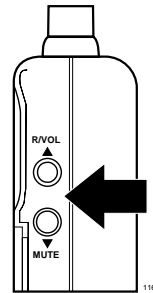

## Ringer Volume Level

- While the telephone is idle, press the **R/VOL** button on the side of the handset to select ring volume. When the handset is returned to the base, the ring volume automatically switches to RING HIGH.

**Note** When the display is set for RING OFF, you receive a vibration alert instead of the audible ring tone.

## Mute

- Press and hold the **MUTE** button to consult another person in the room without the caller hearing you. Release the **MUTE** button to continue the conversation.

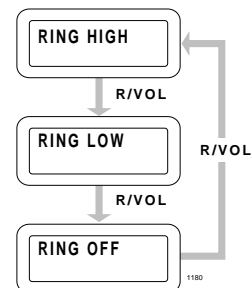

## Using the Handset

- Pick up the handset and press **TALK**. You may see “**ACQUIRING LINK**” on the LCD.

When the cordless digital telephone communicates between the base unit and the handset, the screen goes to standby (shown right), and the telephone is ready to use.

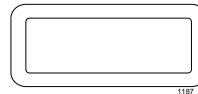

If you see “**NO SERVICE**” on the LCD when talking and the handset is at the range limit of your cordless digital telephone, do the following:

- During a call, move back in range within 20 seconds.
- In standby mode, move back within range.

**Note** When the LCD shows “**DKT MODE**,” the telephone has not been transferred to cordless mode at the base.

## Charging the Handset

- Place the handset on the base unit either face down or face up (shown below), with or without the belt clip attached.

The battery pack in the handset automatically recharges in either position.) For information on charging the Battery Pack, see [page 14](#).

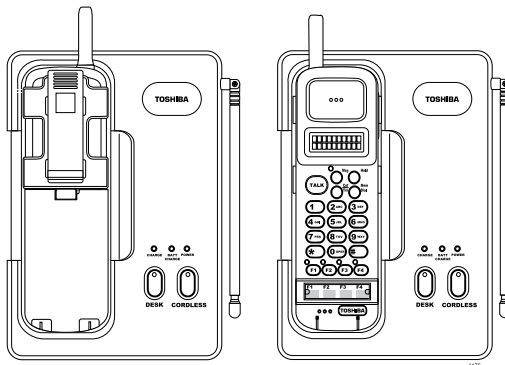



# Switching a Call to Your Cordless Digital Telephone

You can switch a call from the deskset to the cordless digital telephone or vice versa whether idle or talking.

**Note** Transferring while idle or when calls are on hold results in a steady light (skipping the flashing state).

## ► To transfer an active call

1. Press **CORDLESS** on the base unit.

The CORDLESS LED flashes.

2. Pick up the handset and press **TALK**.

The CORDLESS LED lights steady. The DKT LEDs go out and LCD display shows CORDLESS MODE.

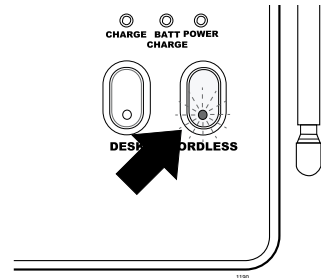

3. When you finish the call, place the handset back on the base unit to automatically hang up.

If the telephones are idle, the transfer takes place immediately without the need to pick up the handset.

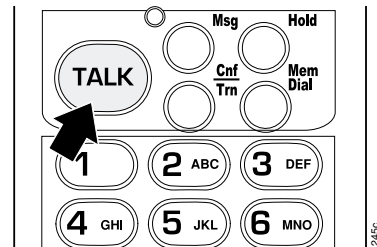

1245c

# Switching a Call to the Desk Telephone

1. Press **DESK** on the base unit.  
The DESK LED flashes.
2. Pick up the handset on your desk telephone.  
The DESK LED lights steady.
3. Hang up your cordless digital telephone handset.

**Note** If the cordless AC Adapter is unplugged or if the Strata CTX system is turned off, the mode automatically changes to the CORDLESS mode.

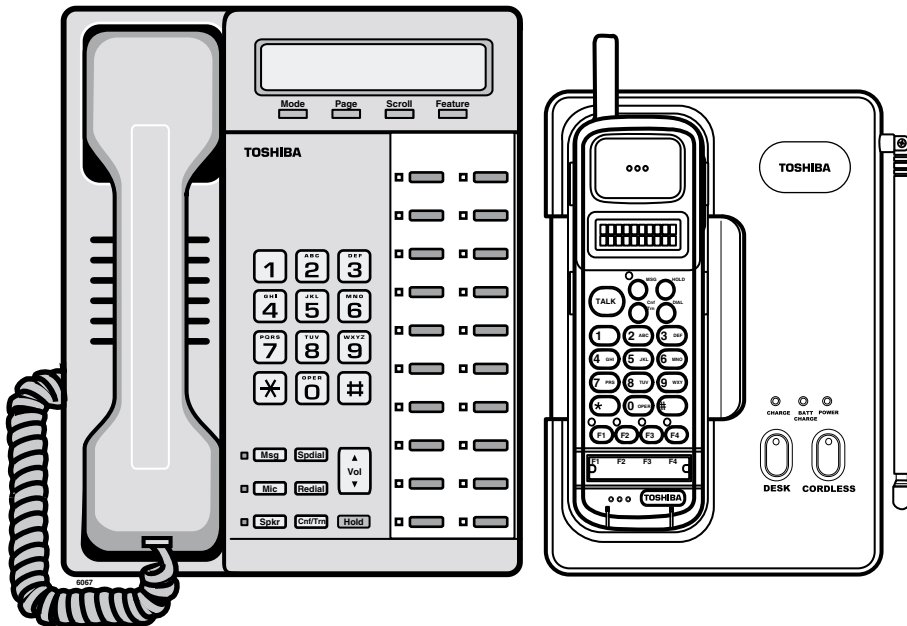
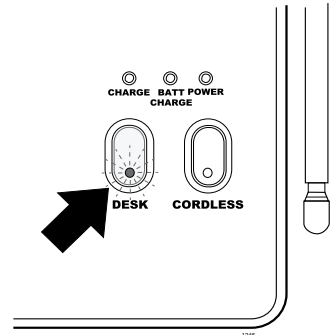

Cordless Digital Telephone with Digital Telephone

# Using Memory

## ► To store a number

1. Remove the handset from the base unit.
2. Press **Mem Dial**.

You hear a beep and see “**PHONE#--**”.

3. Enter the number (up to 16 digits) you want to store.
4. Press **Mem Dial**.

You see “**MEMORY#--**”.

5. Enter the number (01~20) for the memory location you want to use.

You hear a confirmation beep and see the message. The telephone then returns to standby.

**Note** After pressing **Mem Dial** the second time, you have 20 seconds to enter the memory location number you wish to use. Otherwise, an error tone sounds and the unit returns to standby.

## ► To erase a stored number

1. Remove the handset from the base unit.

You see “**STORED**”.

2. Press **Mem Dial** twice.

You see “**DELETE#--**”.

3. Press the memory location number you want to clear.

You hear a long beep and see **DELETED**” which confirms that you have erased that number from memory.

## ► To dial a stored number

1. Remove the handset from the base unit.
2. Press **TALK**

...or press a designated function key with a line assigned to it. For example: Press **F2**.

3. Press **Mem Dial**.
4. Enter the two-digit memory number (01~20) for that number from the keypad.

Your cordless digital telephone then dials the previously stored number. If you select a memory location that does not have a stored number, the handset beeps rapidly and the telephone does not dial.

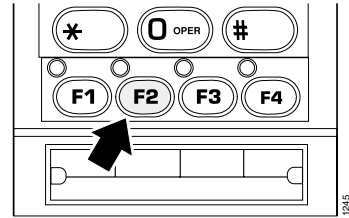

## Chain Dialing

On certain occasions, after dialing a number, you may be requested by the party or service you are calling to enter a special access code, such as when performing a banking transaction. The access code can be stored in one of the 20 memory locations.

1. Remove the handset from the base unit.
2. Make the call by dialing directly or from one of the stored numbers in memory.
3. When prompted by the called party, press **Mem Dial** (as shown) and the memory number of the access code at the appropriate time.

Example:

1. Dial the number for your bank.
2. When the bank requests your account number press **Mem Dial**.
3. Using the handset, enter the two-digit memory location (01~20) for your account number. Your handset dials the number and you may proceed with your transaction.

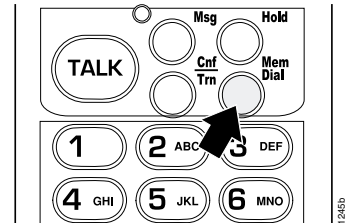

This chapter gives you all of the cordless digital telephone features in alphabetical order beginning on [page 25](#). Your cordless digital telephone provides many of the same features as a 3000-series corded digital telephone. In addition to the **Msg**, **Hold**, **Conf/Trn** and **Mem Dial** functions, you can use your cordless digital telephone's **F1~F4** buttons to invoke the features listed below or to gain multiple-line access.

When sharing the same station, your cordless **F1~F4** buttons perform the same functions as the first four buttons on a 3000-series telephone. The **F1~F4** buttons were preassigned upon system installation. Ask your System Administrator which **F1~F4** button functions you may or may not have.

## Account Code Calls

Account Codes (Forced or Voluntary) can be used for a variety of reasons including billing, tracking, and line restriction applications. Account Codes are assigned in the system as a fixed length (default is six digits) and are recorded by the system, along with the details of the calls, which can be printed on a Station Message Detail Recording (SMDR) report.

## Verified/Non-Verified Account Codes

If programmed for Verified Account Codes, the system checks the account code you entered against a list created by the CTX System Administrator. The code you enter must be on the list for the call to proceed. Non-verified account codes must be of a uniform length specified by the CTX System Administrator.

## Forced Account Codes

Some applications require you to enter an Account Code. These Forced Account Codes may be verified or non-verified, depending upon the application, but in either case, the caller must enter a code before proceeding.

### ► To dial using Forced Account Codes

1. Place a call in the normal method.

If the call requires an Account Code, a burst of tone (Success Tone) is heard after dialing the telephone number alerting you to enter the Account Code.

2. Enter the account number.

When the number of digits designated for account codes has been entered, the number will be checked against the verified list, if chosen, and the call will continue as normal. If the number of digits entered for the account code is not reached or the verified code does not match, then re-order tone is heard and the call is rejected.

You can bypass Forced Account Code requirements with three emergency numbers, including 911. See your CTX System Administrator for these numbers:

- 1) 911                      2) \_\_\_\_\_                      3) \_\_\_\_\_

## Voluntary Account Codes (Verified/Non-Verified)

Voluntary Account Codes are optional. They can be entered during a call and are used for tracking selected calls using SMDR call detail recording option.

If the system is set for Verified Account Codes, station users must enter a specific code when entering the Voluntary Account Code(s) or the code is not validated for the SMDR call report. This does not affect the call.

There are two ways to dial using a Voluntary Account Code:

### ► To dial using the Account Code button

1. After accessing a CO line, press the **Account Code** button. LCD telephones prompt you to “ENTER ACCOUNT CODE NOW.”
2. Enter the account code digits. The LCD prompt disappears upon entry of the first account code digit. After the account code is entered, the time indicator is restored in the LCD.
3. If your station is set for Verified Account Codes, you hear confirmation tone when the code is valid. If the code is invalid, you hear two short tones.
4. Enter the Account Code. Your conversation is not interrupted.

### ► To enter an Account Code using access codes

**Note** It’s a good idea to warn the other party that you will be disconnected momentarily when you enter the access code. Once the code is entered, you will be connected again.

1. After accessing a CO line, press **CNF/TRN**. Once you press **CNF/TRN**, your call is interrupted; you and the other party cannot hear each other. You will hear feature dial tone.
2. Dial **#46**. LCD telephones prompt you to “ENTER ACCOUNT CODE NOW.”
3. Enter the account code digits. The prompt disappears upon entry of the first account code digit. After the account code is entered, the connection is restored and the LCD shows the time.

## Automatic Busy Redial

This feature is not supported by the DKT2004-CT. It must be assigned to your DKT.

# Automatic Callback

When you reach a busy station, you can set Automatic Callback to have the system monitor the busy extension and notify you when it becomes idle.

Automatic Callback can also place you in queue for an available outside line, if you reach a line group in which all lines are busy. When a station or line becomes available, the system rings your telephone. Then when you answer, it automatically rings the intended destination. The amount of time the system will wait for an idle destination is set in system programming.

Automatic Callback is also known as “CO Line Queuing.”

## ► To set Automatic Callback

1. If you hear busy tone after dialing an outside line access code or a station number, press **Auto Callback** or **4**. Busy tone stops, followed by success tone, then busy tone resumes.
2. Hang up. You can make other calls while waiting.
3. When the called station or outside line becomes idle, your telephone rings with a fast LED.
  - If you called a busy station, the extension LED flashes green (incoming call) and the called number displays.
  - If you called a busy outside line, the extension LED flashes green (incoming call rate). The seized line’s number displays.
4. Answer within about three rings (five to 180 seconds, set in programming) to prevent the callback from being cancelled. After you answer, you hear success tone, and the LED flashes green (in-use).

If you hear a busy tone after answering a callback, the called party is already on another call or the line has already been seized or has received an incoming call. Your request is not cancelled. You will be called again the next time a line becomes idle.

If you were attempting to make an outside call, the telephone number is automatically dialed, including the account code or override codes that were used.

## ► To cancel ACB

- Press **Auto Callback** or extension button + **#431**.



# Auto Redial

This feature enables you to automatically redial the last number (outside or [DN]) called by pressing **Redial**. **Redial** must be programmed as one of the four flexible buttons on the telephone.

1. Press an available [DN] or **Line**. Make sure that you press the same [DN] or **Line** that you used to dial the telephone number that you wish to redial. You hear dial tone.
2. Press **Redial**. The last telephone number you dialed is automatically redialed.

# Call Forward

## System

System Call Forward (which is set in Programming) automatically directs calls to a predefined location, such as Voice Mail. See your CTX System Administrator to determine which type of Call Forward you have, as well as the Call Forward location.

## Station

Station Call Forward enables you to assign Call Forward destinations for each extension on your phone. Each extension can be independently set for a different Call Forward feature.

Call Forward must be set prior to receiving the call.

The following calls to your station can be forwarded:

- Internal calls
- Auto Attendant calls
- Outside lines that ring only your station
- Transferred internal or incoming line calls

## Call Forward Categories

You can set Call Forward for the following categories of calls. Within these categories, you can use five different types of Call Forward Settings.

- **Call Forward Any Call** – Forwards any call, whether an internal call or incoming line call.
- **Call Forward - Incoming Line** – Forward incoming line calls only.
- **Call Forward Any Call - Set for Another Station** – Enables you to forward all calls for another telephone within your telephone system.
- **Call Forward - Incoming Line Set for Another Station**– Enables you to set forwarding of incoming line calls for another telephone within your telephone system.
- **Call Forward System** – Forwards the calls to the destination preset for the entire telephone system, commonly voice mail.
- **Call Forward - External Location** – Forwards incoming line calls that ring directly to your extension to a destination outside the system.

You can change your forwarding destination from outside the system using the DISA feature. See your CTX System Administrator for DISA telephone numbers and security code access.

## Call Forward Settings

- **Call Forward All Calls** – Forwards all calls immediately.
- **Call Forward Busy/Do Not Disturb** – Forwards calls immediately when your extension is busy or in Do Not Disturb (DND) mode.

In Tone-first systems with multiple lines, Call Forward Busy forwards calls only when all line appearances are in use. In Voice-first systems, Call Forward Busy forwards all calls any time your telephone is in use.

- **Call Forward - No Answer** – Forwards all calls to your station whenever you do not answer the call within a designated time (set by you when you enable the feature).

- **Call Forward Busy/Do Not Disturb/No Answer** – Forwards all calls to your station whenever you are busy, in the DND mode, or after ringing and you do not answer the call within a designated time (set by you when you enable the feature).
- **Call Forward Cancel** – Cancels the set Call Forward feature. Notice that each category of Call Forward has a different code for canceling.

## Station Call Forward Procedures

The following table contains Call Forward Button sequences. You can do a Call Forward function by entering the button sequence as described.

Some Call Forward features require a Pass Code entry. Use the following procedure to change your Pass Code.

### ➤ To change your Pass Code

- Press Extension button + **#670** + ext. no. + old Pass Code (1~15 digits) + **#** + new Pass Code (1~15 digits) + **#**.

### ➤ To use the Call Forward button sequence

- Follow the instructions in the following table, shown under “Button Sequence.” Some features require additional input, such as:
  - **Destination** – If the destination is an outside number, press **#** after entering the destination. The CTX accepts destination numbers of up to 32 digits.
  - **Timer** – This is a two digit entry representing how long (eight to 160 seconds) your telephone should ring before forwarding the call. If you enter one digit, you must press **#** after entering the single digit.
  - **Pass Code** – A four-digit code established by system programming to prevent unauthorized changes. The code applies to the station to be forwarded; not to the station entering the code.

**Note** In the following table, (Tone) means that a confirmation tone will play at that point in the sequence.

## Features

### Call Forward

**Table 2 Call Forward Procedure**

Feature	Button Sequence
<b>Call Forward Any Call - Internal and Incoming Line Calls:</b> Forwards any call, whether an internal call or incoming line call.	
All Calls	Extension button + <b>#6011</b> (Tone) + Destination No. (Tone)
Busy	Extension button + <b>#6021</b> (Tone) + Dest. No. (Tone)
No Answer	Extension button + <b>#6031</b> (Tone) + Dest. No. (Tone) + Timer + <b>#</b>
Busy No Answer	Extension button + <b>#6041</b> + Dest. No. + Timer + <b>#</b>
Cancel	Extension button + <b>#6051</b> (Tone)
<b>Call Forward - Incoming Line Calls:</b> Forward incoming line calls only.	
All Calls	Extension button + <b>#6013</b> (Tone) + Dest. No. (Tone)
Busy	Extension button + <b>#6023</b> (Tone) + Dest. No. (Tone)
No Answer	Extension button + <b>#6033</b> + Dest. No. (Tone) + Timer (Tone) + <b>#</b>
Busy No Answer	Extension button + <b>#6043</b> + Dest. No. (Tone) + Timer (Tone) + <b>#</b>
Cancel	Extension button + <b>#6053</b> (Tone)
<b>Call Forward Any Call - Set for Another Station:</b> Enables you to forward all calls for another telephone within your telephone system.	
All Calls	Extension button + <b>#6012</b> (Tone) + ext. no. + Pass Code (Tone) + <b>#</b> + Dest. No. + <b>#</b> (Tone)
Busy	Extension button + <b>#6022</b> (Tone) + ext. no. + Pass Code (Tone) + <b>#</b> + Dest. No. + <b>#</b> (Tone)
No Answer	Extension button + <b>#6032</b> (Tone) + ext. no. + Pass Code (Tone) + <b>#</b> + Dest. No. (Tone) + <b>#</b> + Timer + <b>#</b> (Tone)
Busy No Answer	Extension button + <b>#6042</b> + ext. no. + Pass Code + <b>#</b> (Tone) + Dest. No. (Tone) + <b>#</b> Timer + <b>#</b> (Tone)
Cancel	Extension button + <b>#6052</b> (Tone) + ext. no. + Pass Code + <b>#</b> (Tone)

**Table 2** Call Forward Procedure (continued)

Feature	Button Sequence
<b>Call Forward - Incoming Line Call - Set for Another Station:</b>	
Enables you to set forwarding of incoming line calls for another telephone within your telephone system	
All Calls	Extension button + <b>#6014</b> (Tone) + ext. no. + Pass Code + <b>#</b> (Tone) + Dest. No. (Tone) + <b>#</b>
Busy	Extension button + <b>#6024</b> (Tone) + ext. no. + Pass Code + <b>#</b> (Tone) + Dest. No. (Tone) + <b>#</b>
No Answer	Extension button + <b>#6034</b> (Tone) + ext. no. + Pass Code + <b>#</b> (Tone) + Dest. No. (Tone) + <b>#</b> + Timer + <b>#</b>
Busy No Answer	Extension button + <b>#6044</b> (Tone) + ext. no. + Pass Code + <b>#</b> (Tone) + Dest. No. (Tone) + <b>#</b> + Timer + <b>#</b>
Cancel	Extension button + <b>#6054</b> (Tone) + ext. no. + Pass Code + <b>#</b> (Tone)
Change Pass Code	Extension button + <b>#670</b> (Tone) + ext. no. (Tone) + old Pass Code + <b>#</b> (Tone) + new Pass Code (Tone) + <b>#</b>
<b>Call Forward - System:</b>	
Forwards the calls to the destination preset for the entire telephone system, commonly voice mail.	
Activate	<b>#620</b> (Tone)
Cancel	<b>#621</b> (Tone)

## Call Park Orbits

The Call Park feature enables you to hold a call temporarily in a location other than your telephone. These areas are called orbits. You or another telephone user can retrieve a parked call from its orbit by specifying the orbit number. You can specify one of 20 General Park Orbits (7000~7019) or a valid extension number within the system.

Once you have parked a call in an orbit, you can:

- Hang up and retrieve the parked call at a later time
- Originate another call
- Access a voice paging device to announce the parked call for pickup from another station

## Features

### Call Park Orbits

If you park a call and it is not retrieved, it will recall to the parking station and one of the following occurs:

- If your station is idle when the system Call Park recall timer expires, the parked call automatically recalls to your station.
- If your station is busy, the parked call camps on.

If you have an LCD telephone, you can let the system automatically select an available orbit number which displays on your LCD.

#### ► To park a call

1. While on a call, press **Park in Orbit**  
...or **CNF/TRN + #33**. The LED flashes green (consultation-hold).
2. Specify the Park Orbit using one of the following:
  - Press **\*** and the system automatically selects a General Park Orbit between **7000~7019**. The chosen orbit appears on the LCD.
  - Enter a valid extension.
  - Press **#** and the system automatically selects your extension as the orbit.
3. Hang up. The caller's extension or line number and the orbit number are shown. If the parked call is not retrieved within a specified time, the call rings back to your phone. When a parked call recalls your phone, the LCD shows the line or extension that is recalling and the orbit number.

#### ► To retrieve a parked call

1. Press **Park in Orbit**...or your extension button + **#32**.
2. Enter the Orbit Number where the call is parked or **#** for the extension from which you are calling. You cannot use **\*** to retrieve a parked call. The extension LED flashes at the in-use rate when the call is retrieved.

# Call Pickup

You can pick up a call that is ringing another station's extension, a call placed on hold at another station and other types of calls. When you pick up an internal call, the calling station and the called station displays on your LCD.

## Group Pickup

Stations can be assigned in system programming to Pickup Groups. As many as 32 groups can be created to enable you to easily pick up incoming (new or transferred) or internal calls that are ringing stations that are in your group or in other groups. This feature does not pick up held calls. You may belong to more than one group. See your CTX System Administrator for group assignments.

## Page/Internal Call Pickup

This feature picks up Internal (station to station), Group Page, and All Call Page calls. If these types of calls occur at the same time, the pickup priority is station-to-station and then Page calls in the order of occurrence. In some systems, this feature can be applied to pick up All Call Page exclusively.

### ► To perform Call Pickup

1. Press an extension button.
2. Enter a code from the following table.

**Table 3 Call Pickup Feature Codes**

For Incoming Calls:	Dialing	Description
Group	<b>#5#34</b>	Picks up a call ringing to a member of your pickup group.
Directed Extension	<b>#5#5</b> + Primary Ext. No.	Picks up a call ringing on any line appearance of the telephone specified by its Primary extension number.
Directed Group	<b>#5#32</b> + Group No.	Picks up a call ringing to a terminal in the specified Pickup Group.
Directory Number	<b>#5#22</b> + Ext. No.	Picks up a call ringing to the specified extension number only. Other lines ringing on the same phone are unaffected.
Any External Call	<b>#5#9</b>	Picks up any incoming outside line call.

## Features

### Call Pickup

**Table 3** Call Pickup Feature Codes *(continued)*

For Calls On Hold:	Dialing	Description
Local Retrieve	<b>#5#71</b>	Picks up a call held on the telephone from which it is dialed.
Remote Retrieve	<b>#5#72</b> + Primary Ext. No.	Retrieves a call held on the telephone specified extension number.
Outside Line Retrieve	<b>#5#73</b> + Outside Line No. (1~128)	Picks up a call held on the specified CO line regardless of the telephone placing the call on hold. Must enter three digits (e.g., 007).
Directed Extension Retrieve	<b>#5#74</b> + Ext. No.	Picks up a call held on the specified extension number, regardless of the instrument(s) on which it appears.

### Notes

- The Primary extension number is the directory number by which the phone set is defined. Other, non-primary extension numbers may also appear on the phone. By convention, the Primary extension number is assigned to the first button on a multi-button telephone.
- If more than one call is on hold, the call on the telephone's lowest button number is picked up.
- Ringing calls are picked up over held calls as a priority.



# Call Waiting

Call Waiting places an incoming call in queue and alerts you with a warning tone. The [DN] or Line LED flashes at the on-hold rate.

1. If you are talking, press **HOLD**

...or the flashing [DN]. The call you are on is placed on hold and you are connected to the waiting call. The [DN] or **Line** LED lights steady.

...or **Line** if your telephone has the Auto Hold feature. See your System Administrator to find out if you have Auto Hold.

...or the ringing [DN] or **Line**. This disconnects the current call and then connects you to the transferred call. The [DN] or **Line** LED remains steady.

...or **talk**. The existing call is disconnected. The camped-on line rings your telephone and the **Line** LED flashes at the incoming call rate.

2. Press a [DN], then **Line**

...or **talk** again.

# Direct Station Selection Buttons (Hotline)

This optional feature enables you to use a **DSS** button to connect directly to another station's line extension. The DSS LED shows the status (idle/busy) of the station and/or the station's primary extension. For example, a station's DSS button LED shows busy (light steady red) when the station is:

- busy on a call on any button
- idle but all appearances of the station's extension are in use by other stations.

When the station is in DND, the LED flashes red.

## ► To connect directly to another station's extension

1. When connected to a line or another station, press **DSS**.

The original party is put on-hold. You can call a station even if the DSS LED shows busy (steady red).

2. Announce the call...or transfer the call by hanging up or pressing **Release**.

**Note** You can transfer the call to an idle or busy station.

## Do Not Disturb

If your station is in Do Not Disturb (DND) mode, internal, external and transferred calls do not ring your station and Off-hook Call Announce calls are denied. You can continue to make calls while in the DND mode. When originating a call in DND mode, you will hear a short burst of interrupted dial tone followed by continuous dial tone. You can start dialing at any time during either tone.

If you put your Primary extension into DND mode, all calls to that telephone are rejected. If your extension is set for Call Forward-Busy or Call Forward-Busy/No Answer, the call is redirected to the forwarding destination immediately.

If you put an extension other than the Primary extension into DND, only calls to that extension on your phone will be blocked. Appearances of that extension on other telephones continue to ring.

- ▶ **To activate DND on your Primary extension**
  - ▶ Press **Do Not Disturb** or **#6091** (hear Success Tone). The LED lights steady red and DND mode is activated for the entire station.
- ▶ **To activate DND on a non-Primary extension**
  - ▶ Press the desired extension appearance and **Do Not Disturb** or **#6091** (hear Success Tone). The LED lights steady red and DND mode is activated for that extension on your phone.
- ▶ **To deactivate DND**
  - ▶ Press **Do Not Disturb** or **#6092** (hear Success Tone). The LED lights goes out and DND mode is de-activated.

## Setting DND for Another Extension

- ▶ **To activate DND for another extension**
  - ▶ Enter **#6191** (hear Entry Tone) + the Primary extension of the remote extension + the pass code + **#** (hear Success Tone). This sets DND as if activated by the Primary extension on the target telephone.

➤ **To deactivate DND for another extension**

- Enter **#6192** (hear Entry Tone) + the Primary extension of the remote extension + the pass code + **#** (hear Success Tone). This removes DND from the target telephone.

➤ **To change your DND Pass Code**

- Enter **#670** (hear Entry Tone) + ext. no. (hear Entry Tone) + old pass code + **#** (hear Entry Tone) + new pass code + **#** (hear Success Tone).

If you activate DND while a call is ringing, the ringing stops. The LED continues to flash on your telephone and ring on other appearances.

## Door Lock(s)

Your telephone may have **Unlock Door** button(s), which enable you to unlock a door. Each **Unlock Door** button is programmed for a specific lock.

Door Lock No.	Location
0	
1	
2	
3	
4	
5	

Door Lock No.	Location
6	
7	
8	
9	
10	

➤ **To unlock a door**

- Press the specific **Unlock Door** button or **#12** + the Door Lock Number (see above table).

The door unlocks for three~30 seconds (set in system programming). The Unlock Door LED is lit while the door is unlocked.

## Features

### Door Phone(s)

# Door Phone(s)

Door phones can be used to call telephones selected in system programming. When a door phone calls, you hear a distinctive ringing tone, one or five times (set in system programming). You can also call a door phone and monitor the surrounding area.

The number of possible door phones varies by Strata CTX system, with up to 24 as the maximum for larger systems.

LCD telephones display the door phone name ID when calls are made to or from door phones. Check with your CTX WinAdmin programmer to find out the names and locations of your system's door phones and record them in below.

Door Phone	Name/Location	Door Phone	Name/Location

#### ► To answer a door phone call

- Lift the handset while the door phone is still ringing. The extension LED flashes green (in-use) and you are connected to the door phone.

...or to pick up door phone calls ringing someone else's phone, press extension + **#5#5** + directory number.

► **To call/monitor a door phone**

1. With the handset off-hook, press a extension. You hear dial tone and the LED flashes green (in-use).
2. Press **#15** + extension for the door location. A two-way talk-path exists between your telephone and the called door phone. You can audibly monitor the area around the door phone.

► **To call from a door phone**

1. Press the door phone button and then release it. You hear a distinctive ringing tone—one or five times (set in system programming).
2. When answered, speak at a normal voice level in the direction of the door phone.

## Emergency Ringdown

If a station remains off-hook for a programmable period, it can be automatically treated as an Emergency Call and directed to an emergency destination. The station may have partially dialed a number or have dialed no digits at all. Each station is programmed with its specific emergency ringdown destination.

A station number or a group pilot number can be specified as an emergency ringdown destination. In a private network, the station or pilot number must be in the same network node. Remote emergency destination and door phones are not permitted.

## Held Calls

Calls on hold can be released automatically if the held party hangs up and the network provides a hold-release signal.

**Important!** The DKT2004-CT does not support Exclusive Hold.

## Placing Line Appearances or [DN] Calls on Hold

- Press **HOLD**. The Line or [DN] LED flashes green at the on-hold rate.

You hear recall tone when your station is idle (or two times only when busy) if you do not retrieve the held call before “Hold the recall” time set in system programming expires.

## Retrieving Held Calls

- Press **Line** or the [DN] that is on hold.

The Line or [DN] LED flashes at the on-hold rate.

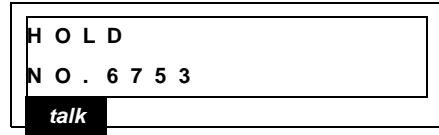

## Using Automatic Hold

Automatic Hold enables you to place a call on hold by pressing another **Line** or [DN]. You do not have to press **HOLD**. You can also switch between a new and the original call without having to press **HOLD**. Automatic Hold is assigned on a station-by-station basis in system programming.

- Press another **Line** or [DN] to receive or originate a new call, while on one call.

The original Line or [DN] LED flashes at the on-hold rate and the original call is placed on hold.

The LED of the new call lights steady and the new line is accessed.

## Switching Between Calls

- Press **Line** or [DN] of the held call.

The Line or [DN] LED just placed on hold flashes at the on-hold rate, and the LED of the Line just accessed lights steady.

# ISDN Outgoing Calling

This feature enables calling over Integrated Services Digital Network (ISDN) trunks, provided that you are connected to a Strata CTX and that you subscribe to ISDN lines. ISDN trunks offer faster call connection setup and more connection circuits.

An ISDN call is initiated automatically with a timer or with a start sequence. The method depends on your system's programming. See your System Administrator to determine the method.

1. Access an outside CO line
2. Dial the number.
3. Press **Start**.

The dialed digits are not sent until you press this button or until the timer expires.

## Subaddress

Subaddress digits can be required for dialing another department or sending a call to a printer.

1. Access an outside CO line.
2. Enter the number.
3. Press **Sub**. Sub informs the system that the digits following are the subaddress.
4. Enter the subaddress.
5. Press **Start**. The dialed digits are not sent until you press this button or until the timer expires.

# Message Waiting

Use your **Msg** LED/button and LCD to see/retrieve message(s).

An extension can receive up to four simultaneous Message Waiting indications and LCD messages. One message is reserved for the Message Center.

Your phone can be programmed to have up to four additional (flexible) Message Waiting buttons/LEDs. Ask and check mark if these buttons have been programmed on your phone. If so, substitute them when the **Msg** button/LED is mentioned in the following steps.

## Responding to a Lit Msg LED

1. Press **Msg**, then lift the handset. Your phone rings the extension or voice mail device that sent the indication. The LED continues to flash red.
2. After answering the message(s), place the handset back on-hook.
3. If the Msg LED continues to flash, you have more messages; repeat Steps 1~3 above to retrieve them. Voice mail devices turn off the LED/LCD indications after a short delay, after you checked all messages.
4. To manually turn off your Msg LED, press your extension button, then press **#409**. Do this step for each message received.



# Off-hook Call Announce

Off-hook Call Announce (OCA) enables you to complete a call to a *busy* digital telephone. Your telephone must be programmed to either announce automatically or to announce after you press a button on your dial pad. The destination telephone must be programmed to accept an OCA. The announcement may be delivered over the handset or the speaker.

Handset OCA can operate on any digital telephone. Speaker OCA requires the addition of a special circuit board inside the DKT speakerphone.

## ► To make an OCA call

- **Manual** – Dial an extension. When you hear busy tone, press **5** and, after one long tone, you can talk through the speaker of the destination telephone. The person you are calling has answering options described below.
- **Automatic** – If your telephone and the extension you are calling have been programmed for Automatic OCA, you can talk through the speaker of the destination telephone without hearing the busy tone and without dialing **5**.

# Override Calls

The available override features are:

## Busy Override

Ring Over Busy Override enables you to send a muted ring tone to a busy station to indicate a call is waiting. The Busy Override (BOV) muted ring can be programmed for each station to be two muted rings only or continued muted rings until the call is answered. This option applies to the station receiving the muted ring. The muted ring can be sent to the telephone speaker or to the telephone handset/headset and speaker.

## ► To use Busy Override

- After reaching a busy station, press **2**. A muted tone is heard at the busy station, indicating that a call is waiting. The station number displays.

## Do Not Disturb Override

Do Not Disturb (DND) Override lets you send a call waiting tone or ringing to a station in DND mode to indicate that a call is coming in. Your telephone may be programmed to block DND Override from other telephones. Your station's LCD shows the station you have called is in the DND mode.

OCA is possible to DND stations from stations that are programmed for DND Override.

### ► To use DND Override

- After reaching a station in DND mode, press **2**. A tone signal is heard at the DND station, indicating a call is coming in. On your station, the LCD shows the station number you have overridden.

Your LCD displays **DND OVR DENY**, if the station you called denies DND Override.

## Executive Override

Executive Override enables you to enter an established conversation. Your telephone can also be programmed to block Executive Override from other telephones.

### ► To perform Executive Override

- After reaching a busy station, press **3**

...or, if you have an LCD telephone, use the **OVRD** Soft Key.

You enter a conference with the busy station and the party to whom he was talking. The called parties may hear an optional tone signal prior to your entering the conversation.

Your LCD displays **EXEC OVR DENY**, if the station you called denies Executive Override. If you do not have Override privileges, you will camp on.

## Class of Service Override

By dialing a Class of Service Override code, a user can change a station's set of privileges to one associated with the override code. When the call is terminated and another is attempted from the same station, the original Class of Service is applied. This allows selected users to override restrictions that are placed on any telephone in the system.

### ► To perform Class of Service Override

1. Access an outside line. You hear dial tone and the LED flashes at the in-use rate.
2. Press **Cnf/Trn + #471**. Dial tone stops. Your LCD prompts you to enter a code.
3. Enter the Class of Service Override Code (four digits). You hear dial tone. For security reasons, the override codes are only available on a selected basis. See your CTX System Administrator.
4. Dial a telephone number.

## Privacy Override

This feature enables you to enter an established call on a line you share with another telephone. Up to two station users can enter an existing CO line-to-station call (i.e., up to three stations can be connected to a CO line). You can also use this feature if the station that is already connected to the CO line is in the Privacy Release mode.

Station users with **Privacy Release** can allow stations with the shared button appearance to enter their conversations, even if the station entering the conversation is not programmed for Privacy Override. (see “[Privacy](#)” on [page 49](#).)

## Paging

Station users can make page announcements to telephones and external speakers. Check with your CTX System Administrator to find out the zone numbers for various paging groups.

### ► To make a Page Announcement to a phones or external speakers

1. Lift the handset, press extension and enter a paging access code.
2. Make your announcement, then hang up.

#### ► To make a Group Page

- Press **Group Page** and enter the Group number (01~16)  
...or press extension + **#31** and enter the zone number.

## Answering a Page

- To answer a Group Page, lift the handset off-hook, press extension + **#5#35** and enter the Group number.
- To answer an External Group Page, lift the handset off-hook, press extension + **#5#36** and enter the Group number.

## All Call Page

You can make an All Call Page to telephones assigned to the “All Call Page Group.” Stations are assigned to the “All Call Page Group” in system programming.

#### ► To make an All Call Page

1. With the handset off-hook, press **All Call Page**...or extension + **#30**. This pages all phones in the All Call Page Group but, depending on system programming, you may or may not page external speakers.
2. Make your announcement then hang up.

#### ► To answer an All Call Page

- Lift the handset off-hook, press extension + **#5#35**.

## Emergency Page

An Emergency Page overrides Group Pages or All Call Pages to telephone and external paging devices.

- To make an Emergency Page, lift the handset off-hook, press extension + **#37**.
- To make an Emergency Page to a group, lift the handset off-hook, press extension + **#38** and enter the Zone number.

# Privacy

Privacy controls the ability of more than one person to use the same extension or CO line at the same time. Privacy applies to multiple appearances of extensions, Phantom extensions, outside Lines and outside Line Group buttons. The application of Privacy to individual telephones is controlled in system programming.

By default, the system is private. If you are in a conversation, another telephone with an appearance of the line on which you are talking cannot intrude unless that telephone has been programmed for Privacy Override. In that event, the other telephone may enter and leave the conversation at will. If all users are provided with Privacy Release in Class of Service, the system will function as non-private.

Your phone may be equipped with a **Privacy Release** and/or a **Privacy on Line** button. On a normally private telephone, **Privacy Release** allows other appearances of your line to join the conversation. On a normally non-private telephone, **Privacy on Line** allows you to exclude others. The Privacy condition may be toggled at any time during a conversation. At the end of the conversation, the line's privacy condition returns to its original state.

## ► To use Privacy Release

- While on a CO line call, press **Privacy Release**. The LED lights red. The outside line flashes at all appearances. When another station user enters the outside line call by pressing a common outside **Line**, the Privacy Release LED turns Off. To add a third station, press **Privacy Release** again; the process repeats.

## ► To set/cancel Privacy

- Press **Privacy on Line** to set privacy. The LED lights steady red. Others are blocked from entering your outside line calls when they press a common **Line** button  
...or press **Privacy on Line** again to cancel the feature. The LED turns Off.

# Redial

Use this button to redial the last number dialed from your phone.

- To redial the last number, press **Redial** or **\*0**.

## Release and Answer

This feature enables you to automatically disconnect or transfer an active call and answer a new call with the push of a button, instead of with the handset.

**Note** Your telephone must be programmed with **Release and Ans.**

- Press the **Release and Ans.** The Line or [DN] LED flashes to indicate a new incoming call while you are connected to the existing call. You hear a muted, Busy Override or Camp-on-busy tone. The original call is released and you can answer the new call.

...or **CNF/TRN** and dial a “transfer-to” destination. Then, press **Release and Ans.** This transfers the original call and answers the new call.

...or **DSS** of a “transfer-to” destination, then press **Release and Ans.** This transfers the original call and answers the new call.

## Speed Dial

Speed Dial enables you to dial a sequence of up to 32 digits with a shorter code. Dial sequences can include telephone numbers, authorization codes, passwords feature activation codes and pauses. Speed Dial may be used to originate a call or invoked after a call is established.

There are two types of Speed Dial.

- **Station** – Your CTX System Administrator allocates a block of up to 100 personal speed dial numbers in increments of 10 per phone. You have exclusive use of them.
- **System** – All telephones in your system can share a list of up to 800 System Speed Dial numbers under the exclusive control of the CTX System Administrator. In some cases, System Speed Dial will allow you to reach numbers that you would not be allowed to dial directly from your telephone.

## Making a Call Using Speed Dial

1. Dial \*  
...or press **Spdial**
2. Then, dial the Station or System Speed Dial Number. Station Speed Dial numbers occupy numbers 100~199. System Speed Dial numbers occupy numbers 200~999.

## Tone/Pulse Dialing

With some older Central Offices, you may have to make calls on outside lines programmed for rotary dial pulses. This feature enables you, while on these lines, to switch to tone dial to access remote equipment (such as an answering machine) requiring touchtones.

**Note** With ISDN calls, when **Tone Dial Select** is pressed, all of the digits entered after that point will be sent with touchtones.

### ► To change Tone Dialing

1. Access an outside line.
2. Dial a telephone number.
3. While on the call, press **Tone Dial Select**. Although the outside line is programmed for rotary dial pulses, access the outside line and dial the telephone number like any other call described in this user guide.

The Tone LED lights steady red and you are able to send touchtones with your dial pad. The feature is cancelled when the call is completed.

## Voice Mail - Direct Transfer

The Strata CTX enables you to transfer a call directly to a voice mailbox without first ringing that person's telephone.

### ► To transfer a call directly to Voice Mail (VM)

1. While on a call, press **CNF/TRN**. You hear feature dial tone.22
- 1.
2. Enter **#407**. You hear entry tone.

## Features

### *Voice Mail - Direct Transfer*

3. Enter the VM mailbox number (usually the same as the extension number), then press **#**. The call transfers immediately and your extension becomes idle.



# Feature Access Codes

# A

This appendix contains Feature Access Codes which are entered as a sequence on your telephone to use a particular feature.

Also, the Call Forward Feature Access Codes sometimes have special requirements for entering a destination and a timer. Refer to [“To use the Call Forward button sequence”](#) on [page 31](#) for more details on these entries.

**Table 4 Feature Access Codes**

Feature	Feature Access Code Sequences
<b>Account Code</b>	<b>CNF/TRN + #46</b> + Account code digits
<b>Attendant Console</b>	<b>0</b>
<b>Automatic Busy Redial - On</b>	<b>#441</b>
<b>Automatic Busy Redial - Off</b>	<b>#442</b>
<b>Automatic Callback Cancel</b>	<b>#431</b>
<b>Background Music</b>	
Phone Speaker On	Ext. button + <b>#490</b> + source number + #
Phone Speaker Off	Ext. button + <b>#491</b>
External Speaker On	Ext. button + <b>#492</b> + source number + #
External Speaker Off	Ext. button + <b>#493</b>
<b>Call Forward - Any Calls (Internal and External)</b>	
All Call	Ext. button + <b>#6011</b> + Dest. No
Busy	Ext. button + <b>#6021</b> + Dest. No.
No Answer	Ext. button + <b>#6031</b> + Dest. No. + Timer + #
Busy No Answer	Ext. button + <b>#6041</b> + Dest. No. + Timer + #
Cancel	Ext. button + <b>#6051</b>

## Feature Access Codes

### Voice Mail - Direct Transfer

**Table 4** Feature Access Codes (continued)

Feature	Feature Access Code Sequences
<b>Call Forward - External (Outside) Calls</b>	
All Call	Ext. button + <b>#6013</b> + Dest. No.
Busy	Ext. button + <b>#6023</b> + Dest. No.
No Answer	Ext. button + <b>#6033</b> + Dest. No. + Timer + #
Busy No Answer	Ext. button + <b>#6043</b> + Dest. No. + Timer + #
Cancel	Ext. button + <b>#6053</b>
<b>Call Forward - Remote Activation</b>	
All Call	Ext. button + <b>#6012</b> + ext. no. + Pass Code + # + Dest. No. + #
Busy	Ext. button + <b>#6022</b> + ext. no. + Pass Code + # + Dest. No. + #
No Answer	Ext. button + <b>#6032</b> + ext. no. + Pass Code + # + Dest. No. + # + Timer + #
Busy No Answer	Ext. button + <b>#6042</b> + ext. no. + Pass Code + # + Dest. No. + # + Timer + #
Cancel	Ext. button + <b>#6052</b> + ext. no. + Pass Code + #
<b>Call Forward - External Calls - Remote Activation</b>	
All Calls	Ext. button + <b>#6014</b> + ext. no. + Pass Code + # + Dest. No. + #
Busy	Ext. button + <b>#6024</b> + ext. no. + Pass Code + # + Dest. No. + #
No Answer	Ext. button + <b>#6034</b> + Dest. No. + # + ext. no. + Pass Code + # + Dest. No. + # + Timer + #
Busy No Answer	Ext. button + <b>#6044</b> + Dest. No. + # + ext. no. + Pass Code + # + Dest. No. + # + Timer + #
Cancel	Ext. button + <b>#6054</b> + ext. no. + Pass Code + #
Change Pass Code	Ext. button + <b>#670</b> + ext. no. + old Pass Code + # + new Pass Code + #
<b>Call Forward - System</b>	
Activate	<b>#620</b>
Cancel	<b>#621</b>
<b>Call Park</b>	
Activate	<b>CNF/TRN + #33</b> + Orbit Number
Retrieve	Ext. button + <b>#32</b> + Orbit Number
System Orbits	<b>7000~7019</b>

**Table 4 Feature Access Codes** (continued)

Feature	Feature Access Code Sequences
<b>Call Pickup</b>	
Incoming - Group Pickup	Ext. button + <b>#5#34</b>
Incoming - Directed Terminal Pickup	Ext. button + <b>#5#5</b> + Ext. Number to be picked up
Incoming - Directed Group Pickup	Ext. button + <b>#5#32</b> + Group Number to be picked up
Incoming - Directed Extension Pickup	Ext. button + <b>#5#22</b> + Ext. Number
On hold - Local Retrieve	Ext. button + <b>#5#71</b>
On hold - Remote Retrieve	Ext. button + <b>#5#72</b> + Remote Ext. No.
On hold - Outside line Retrieve	Ext. button + <b>#5#73</b> + Line on hold
On hold - Directed Extension Retrieve	Ext. button + <b>#5#74</b> + Ext. No. on hold
Incoming - Any External Call	Ext. button + <b>#5#9</b>
<b>Conferencing - Three Way</b>	
<b>#494</b>	
<b>Dialing</b>	
Dial *	<b>441</b>
Dial #	<b>440</b>
<b>DISA Security Code - Change</b>	
<b>#658</b> + old Security Code (1~15 digits) + <b>#</b> + new Security Code (1~15 digits) + <b>#</b>	
<b>Do Not Disturb</b>	
Local - On	<b>#6091</b>
Local - Off	<b>#6092</b>
Remote - On	<b>#6191</b> + ext. no. + Pass Code Number + <b>#</b>
Remote - Off	<b>#6192</b> + ext. no. + Pass Code Number + <b>#</b>
<b>Door Lock Control</b>	
<b>#12</b> + Door Lock Number	
<b>Door Phone Calling</b>	
<b>#15</b> + Door Phone No.	
<b>Emergency Call</b>	
<b>#911</b>	
<b>Flash - Short</b>	
<b>#450</b>	
<b>Flash - Long</b>	
<b>#451</b>	

## Feature Access Codes

### Voice Mail - Direct Transfer

**Table 4** Feature Access Codes (continued)

Feature	Feature Access Code Sequences
<b>LCD Language (Change)</b>	<b>#495</b> + Language No.
<b>LCR (Outgoing Call)</b>	<b>9</b>
<b>Message Waiting (MW)</b>	
Release a received MW	<b>#409</b>
Retrieve a received MW	<b>#408</b>
Activate MW at another Station without Ringing	<b>#63</b> + Ext. no.
Cancel MW at another Station without Ringing	<b>#64</b> + Ext. no.
<b>Messaging - Advisory</b>	
Advisory Message - Activation	<b>#411</b> + Message No.
Advisory Message Cancellation	<b>#412</b>
<b>Private Network Access Code</b>	<b>8</b> + Private Network No.
<b>Night Ring Answer</b>	<b>#5#39</b>
<b>Off-hook Call Announce (Manual Mode)</b>	Voice First: <b>2</b> ; Tone First: <b>1, 21, or 12</b>
<b>Override</b>	
Busy, Do Not Disturb	<b>2</b>
Executive	<b>3</b>
<b>Paging</b>	
Page All Groups	<b>#30</b>
Page Individual Groups	<b>#31</b> + Group Number
Emergency Page - Individual Group	<b>#38</b> + Group Number
Emergency Page - All Groups	<b>#37</b>
Answer Page - All Groups	<b>#5#35</b>
Answer for External Group Page	<b>#5#36</b> + Zone Number
<b>Repeat Last Number Dialed</b>	<b>*0</b>

**Table 4** Feature Access Codes (continued)

Feature	Feature Access Code Sequences
<b>Speed Dial Register</b>	<b>#66</b>
Station (00~99)	<b>* 1</b> + Index Number (00~99)
System	<b>* 2</b> + Index Number (000~099)
	<b>* 3</b> + Index Number (100~199)
	<b>* 4</b> + Index Number (200~299)
	<b>* 5</b> + Index Number (300~399)
	<b>* 6</b> + Index Number (400~499)
	<b>* 7</b> + Index Number (500~599)
	<b>* 8</b> + Index Number (600~699)
	<b>* 9</b> + Index Number (700~799)
<b>Start Application</b>	<b>#18</b>
<b>Substitution of Dial “#”</b>	<b>440</b>
<b>Substitution of Dial “*”</b>	<b>441</b>
<b>Travelling Class Override</b>	
Enter Code	<b>#471</b>
Change Code	<b>#69</b> + Index Number + old Code + # + new Code + #
User Programming Mode	<b>#9876</b>
<b>Voice Mail (VM)</b>	
Direct Transfer to Voice Mail	<b>#407</b> + Ext. Number
<b>Volume Control - Beep</b>	<b>#6101</b>
<b>Volume Control - Ringing</b>	<b>#6102</b>

## **Feature Access Codes**

*Voice Mail - Direct Transfer*

# Troubleshooting and Specifications

---

## B

This appendix contains additional information for your cordless digital telephone. It is divided into:

- Installing Optional Headset
- Troubleshooting
- Range and Performance
- Nine Simultaneous Conversation Channels
- Radio Interference
- Specifications
- Available Optional or Replacement Items
- Access Codes

# Troubleshooting

If your cordless telephone is not performing to your expectations, try these suggestions. If you are still unable to resolve the problems, contact your telephone system administrator. Do not attempt to service this unit yourself. All service must be done by qualified service personnel.

Problem	Suggestion
CHARGE LED does not come on when handset is placed on base unit.	<p>Make sure the AC adapter is plugged into the base unit and wall outlet.</p> <p>If the AC adapter is plugged into a wall outlet with a switch, make sure the switch is turned on.</p> <p>Make sure the handset is properly seated in the base unit.</p> <p>Make sure the nickel-cadmium battery pack is properly placed on the handset.</p> <p>Make sure that the charging contacts on the handset and base unit are clean.</p>
Conversation interrupted frequently.	<p>Make sure that the base unit antenna is fully vertical.</p> <p>Move closer to the base unit.</p>
Press <b>TALK</b> and get no dial tone.	<p>Move closer to the base unit.</p>
Cannot configure the cordless digital telephone.	<p>Check both ends of all telephone line cords for good connections.</p> <p>Make sure the AC adapter is plugged into the base unit and wall outlet.</p>
Handset does not ring.	<p>The nickel-cadmium battery may be weak. Charge the battery pack for 8-10 hours.</p> <p>Check the Ringer Alert setting. It may be set to Ring Off.</p> <p>Make sure the base unit antenna is fully vertical.</p> <p>The handset may be too far away from the base unit.</p>
Tone noise	<p>Move cordless telephone to the right side of the DKT.</p>
Other problems	<p>Contact your telephone system administrator.</p>



## Range and Performance

The cordless digital telephone is designed to operate up to 1.1 miles from the base in a completely unrestricted test environment. Typically, ranges of 300 to 400 feet are possible, depending upon the structure of the building the telephone is used in.

For optimum range and performance from your cordless digital telephone, try the following options:

- Place the base units at least 3 to 6 feet away from the deskset; at least 3 feet from metal structures; and at least 6 feet from computers, fax machines or other electronic equipment.
- Use an AC outlet not associated with computer or electromagnetic equipment.
- Wherever possible, put the base units in the middle of the coverage area.
- Mount the base units high in the room, for maximum range.
- Locate 3 or less cordless telephones 12 feet apart.
- Locate 4 to 10 cordless telephones 20 feet apart.

## Nine Simultaneous Conversation Channels

The cordless digital telephone has nine operating channels available.

A common misconception is that this limits a customer to nine cordless phones. This is not the case. Each cordless digital telephone can operate on any of the nine channels. When you turn on a cordless digital telephone, the phone selects an available channel within its' range. In a given cordless range, nine simultaneous calls can be made. In most businesses, it is unlikely that all nine channels will be in use at the same time. Typically 20 to 30 phones can share the 9 channels.

Another factor is the distribution of the phones in a facility. If your cordless digital telephones are disbursed throughout a facility, there should not be contention for channels. If there are more than nine cordless digital telephones in one area and nine users are using their cordless phones, a tenth user would not be able to connect at that time.

# Radio Interference

Radio interference may occasionally interrupt your conversations. When this happens, remember that your unit is not defective. If these noises continue, and are too distracting, move to a different location while you are talking on the telephone. (As noted in the preceding Range section, you may need to move the base unit as well.) If the situation persists, contact your telephone system administrator.

## Specifications

General	
Frequency Control	Frequency Synthesizer
Modulation	MSK
Operating Temperature	-10° to 50° C
Base Unit	
Receive/Transmit Frequency	903.20 to 924.95 MHz (9 channels)
Power Requirements	10VDC from supplied AC adapter
Size	Width 5.0 inches Depth 7.5 inches Height 3.7 inches
Weight	Approximately 1 lb., 5 oz.
Handset	
Receive/Transmit Frequency	903.20 to 924.95 mHz (9 channels)
Power Requirements	Rechargeable Nickel-Cadmium battery pack
Size	Width 2.125 inches Depth 0.875 inches Height 6.5 inches with antenna
Weight	Approximately 10.5 oz. with battery
Battery	Capacity 400 mAh, 4.8V Talk Mode 2.5 hours (typical) Standby Mode 42 hours (typical)

# Index

---

## A

- about this book
  - related documents, [vii](#)
- access codes, [53](#)
- account code, [53](#)
  - calls, [25](#)
  - forced account codes (verified/non-verified), [26](#)
- account code calls, [25](#)
- advisory messaging, [56](#)
- all call page, [48](#)
- attendant console, [29](#), [53](#)
- automatic
  - busy redial, [53](#)
  - callback, [29](#)
  - callback cancel, [53](#)
  - hold, [42](#)
- auto preference, [7](#)

## B

- background music (BGM), [53](#)
- base unit controls and functions, [5](#)
- battery, [14](#)
  - charging extra packs, [14](#)
  - extending life, [15](#)
  - removing and charging, [14](#)
- busy override, [45](#)

## C

- call
  - attendant console, [29](#)
  - hold, [41](#)
  - park orbits, [33](#)
- call forward, [29](#)
  - access codes, [53](#)
  - any call, [30](#)
  - definitions, [30](#)
  - fixed, [33](#)
  - pass code, [31](#)
  - station, [29](#)
  - system, [29](#), [54](#)
- call park, [54](#)
  - orbits, [33](#)
- call pickup, [35](#), [55](#)
- chain dialing, [24](#)
- change pass code, [31](#)
- conferencing, [55](#)
- configuration, [17](#)

## D

- dial
  - a stored number, [23](#)
- direct station selection
  - buttons, [37](#)
- direct station selection buttons (hotline), [37](#)

**DISA**

security code, 55

do not disturb, 38, 55

override, 46

door lock, 39

control, 55

door phone, 40

calling, 55

DSS, 37

**E**

emergency

call, 55

page, 48

erase a stored number, 23

executive override, 46

**F**

feature access codes, 53

features, 6

flash, 55

forced account codes (verified/non-verified), 26

**G**

group pickup, 35

**H**

handset, 19, 20

charging, 20

volume level, 19

**I**

installation, 7

installing optional headset, 60

ISDN

buttons, 51

**L**

language changes, 56

LCD

name/number display, 44

LCR

dialing out, 56

low battery symptoms, 15

**M**

memory, 20

message waiting, 37, 44, 56

messaging, 44

advisory, 56

Msg button/LED, 44

**N**

name/number display, 43

night ring answer, 56

**O**

off-hook call announce  
(OCA), 45

off-hook call announce (OCA), 45, 56

override

access codes, 56

busy, 45

do not disturb, 46

executive, 46

privacy, 47

travelling class, 57

override calls, 45

**P**

paging, 35

access codes, 56

pass code, 31

pick up group calls, 35

privacy, 49  
    on-line, 47  
    override, 47  
private network access, 56

## R

radio interference, 62  
range, 61  
release and answer, 50  
repeat last number dialed, 56  
ringer volume level, 19

## S

simultaneous conversation channels, 61  
specifications, 62  
speed dial, 50  
    access codes, 57  
spread spectrum technology, 1  
start (ISDN button), 43  
start application, 57  
store  
    a number, 23  
sub (subaddress ISDN button), 43  
switching calls  
    to cordless digital telephone, 21  
    to desk telephone, 22

## T

tone/pulse dialing, 29  
tone/pulse dialing, 51  
transfer  
    an active call, 21  
travelling class override, 57  
troubleshooting, 60

## U

user programming, 53, 57

## V

voice mail  
    access codes, 57  
    direct transfer, 51  
volume control, 57  
voluntary account codes (verified/non-verified), 27